

# AT46SAW

## Programmable Selective Amplifier





## Technical Specifications

N° Input BI/BII (40... 108 MHz)	1	
N° Input BIII/DAB (170... 320 MHz)	1	
N° Input UHF Selectable 470... 790 MHz/470... 700MHz	2	
N° Programmable Clusters	6	
N° Channel per Cluster	1... 7 (8... 56 MHz)	
UHF Cluster Settings	UHF1	UHF2
	6	UHF
	5	1
	4	2
	3	3
Clusters Gain Adjustment	0... 30 dB	
Clusters Selectivity +/- 10 MHz	12 dB	
VHF Input attenuators	0... 25 dB	
UHF Input attenuators	0... 20 dB	
UHF Input range	60... 100 dB $\mu$ V	
Gain UHF	40 dB	
Gain VHF	35 dB	
Max Output Level	119 dB $\mu$ V	
Noise Figure	VHF 6,5 UHF 6,5	
Return Loss In/Out	>12 dB	
Remote Power Supply VHF – UHF	12/24 VDC 100 mA	
Supply Voltage (External power supplier)	230VAC +/- 10%	
Max Power Consumption	8 W	
Programming Port	USB	
Dimensions	192 x 217 x 37 mm	

## Electrical Diagram

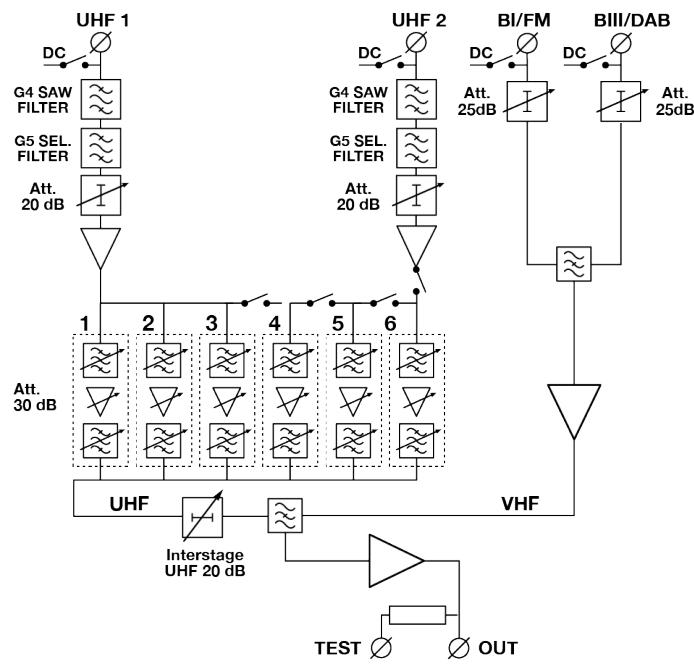

Congratulations for buying the AT46SAW programmable selective amplifier.

Read carefully the following instructions to ensure correct operation of the amplifier.

### **Safety instructions**

- Do not expose the amplifier to extreme temperatures.
- Place the amplifier in a dry and well-aired location.
- Install the unit on a vertical wall, or in a waterproof cabinet to a minimum IP55 rating, and fix it safely using the special through holes supports.

### **INSTALLATION AND START-UP**

- Connect the ground wire (you find it on the amplifier's chassis) to the IRS or MATV earth.
- Connect the TV aerial(s) to the amplifier's inputs.
- Terminate the unused inputs with 75Ω terminators.
- Connect the supplied power pack.
- Only then connect the amplifier to the mains plug.

#### **IMPORTANT!**

**Use only the power pack supplied together with the amplifier.**

**The use of other power packs can cause malfunctioning and irreparable damages which will invalidate any warranties.**

### **Programming**

It is possible to programme the AT46SAW from either the front panel controls or from a the GUI software which is downloadable free of charge from our website

### **LEM Graphic User Interface (GUI)**

From the download area in our website <http://www.lemelettronica.it> it is possible to download a special free PC compatible software conceived to operate with the AT46SAW amplifier from your PC.

#### **Hardware requirements**

PC Windows compatible with USB interface.

Processor 800MHz or more.

256Mb RAM

USB A-B cable.

#### **Software minimum requirements**

Windows XP SP2 operating system or more recent Microsoft Framework .NET 3.5\* or higher and langpack (free download from Microsoft website).

### **Installation procedure**

Close all the active applications (included antivirus programs)

Start the Setup.exe program

Follow the guided procedure until the installation is completed

The program needs the **Framework.NET 3.5** or higher to work.

It is usually in the PC if there is a recent version of Windows XP. If not the **Framework.NET** can be freely downloaded from the Microsoft website.

## Use

If correctly installed and started the GUI software will automatically find the USB interface of the AT46SAW amplifier, then all the setting, reading and storing operations, are available.

## Android Tablet e Smartphone Programming

### Hardware requirements

Android OS Tablet or Smartphone with USB supporting the On The Go (OTG) mode

USB A-B Cable

USB-OTG Cable Adapter

### Software requirements

Android OS 4.0 or successive release

### Application Installation Procedure

The application **LEMGUI** can be free downloaded from Google Play <https://play.google.com/>

Power the AT46SAW connecting the power supplier unit.

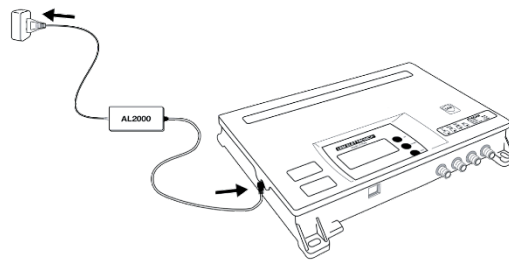

Connect the USB-OTG cable and the USB A-B cable to tablet/smartphone.

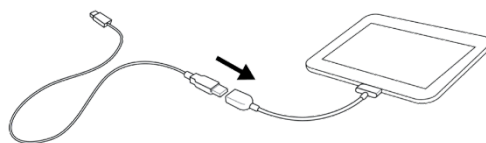

Swith on the tablet/smartphone and connect The cable to AT46SAW.

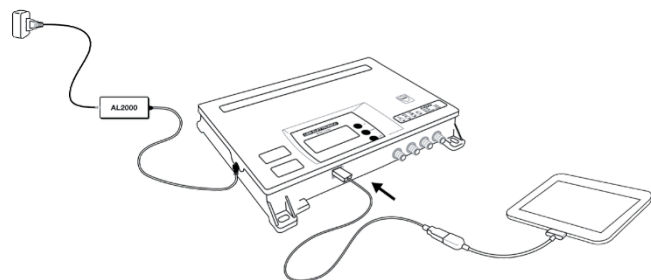

The tablet/smartphone automatically activate the application recognizing the programmable amplifier model.

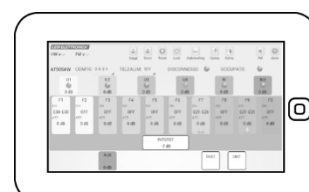

## Manual Programming (from the keys on the front panel of the amplifier)

At start-up (i.e. connection of the mains cable) the letter “b” will appear on the display. It indicates the microprocessor boot phase. Then the release “Firmware” will be indicated for a while to confirm the correct system initialization.

At the end of the start-up procedure the amplifier is in the “POWER ON” status.

This status is indicated by the lighting of the fourth LED on the display.

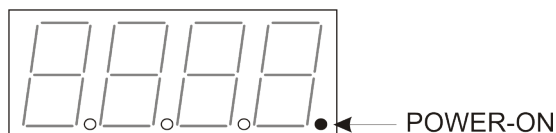

The “POWER ON” status denotes that the amplifier is operative and ready to be programmed.

## PARAMETERS SET AND PROGRAMMING

A 4 digit display indicate the amplifier’s selectable modes. Using the “UP”, “DOWN” and “ENTER” keys you can see the factory set parameters and program new ones.

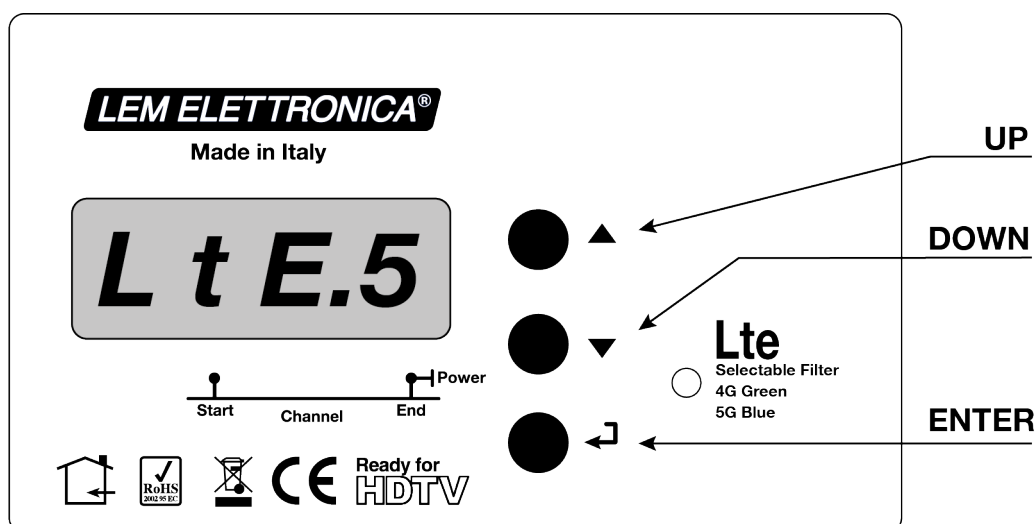

LED fixedly on	Parameters visualisation
LED blinking slowly	Parameters configuration
LED blinking rapidly	Not desirable programming or setting

To access the UHF input attenuators’ programming menu: press the “DOWN” key for 3 seconds.

To access the clusters’ programming and UHF-VHF output level adjustment menu: press the “ENTER” key for 3 seconds.

To access the programming menu of the remote supplies by the inputs: press the “UP” key for 3 seconds.

Any change of the parameters (blinking display) must be confirmed by pressing the “ENTER” key. In this way it will be permanently stored.

### **Note**

To quit any programming menu: press the “UP” and the “DOWN” keys simultaneously, this will happen automatically after 5 minutes if the menu is unused.

### 1) Lte G4 / G5 selection filter

The AT46SAW UHF inputs are protected by selectable Lte G4 or G5 filters.

To select the proper Lte filter press the key “ENTER” for 3 seconds and the display will prompt **Lt E.5** for G5 (blue led) to set a different Lte filter press again “ENTER” and the display start to blink, press “UP” or “DOWN” keys to select the proper filter and confirm pressing “ENTER”.

**Lt E.5 = 5G mode (blue led) UHF channel range 21... 48**

**Lt E.4 = 4G mode (green led) UHF channel range 21... 60**

### 2) UHF inputs' attenuator

This is manually adjustable from 0 to –20 dB.

To access the UHF attenuators' programming menu:

- press the “DOWN” key for 3 seconds.
- the display will show the word **U1.00.** : this indicates that the UHF1 input attenuation level is at zero.
- press the “ENTER” key. The display will start blinking. This indicates the parameters' setting mode.
- press “UP” or “DOWN” to adjust the attenuation level from 0 to –20dB.
- press “ENTER” again to confirm your choice. The display will return with a fixed light, this indicates that the new setting was saved.

**NOTE: the attenuation settings will be cancelled if you do not press the “ENTER” key for confirmation at the end of the procedure.**

To adjust the UHF2 and UHF3 input attenuators:

- press “UP” or “DOWN” to choose the desired attenuator.
- then follow the described procedure above.

To leave the remote power supply setting menu:

- press the “UP” and “DOWN” keys simultaneously.
- the display will return to “POWER ON” status.

### 3) selection of the cluster-groups' configuration

There are 4 possible configurations:

Input	UHF1	UHF2
Cluster-groups	6	UHF
	5	1
	4	2
	3	3

You can enter into these configurations by pressing the “ENTER” key for 3 seconds.

The display indicates the selected configuration: it views the cluster-groups corresponding UHF inputs.

Note:

The cluster-group 5 - 1 assigns: 5 clusters to the UHF1 input and 1 cluster to the UHF2 input.

Each cluster can be programmed for a bandwidth variable from 8 to 56 Mhz. with a 8 Mhz. step, that means from 1 to 7 UHF channels with 1 channel steps.

To select a different configuration:

- press "ENTER" : the display starts blinking.
- press "UP" or "DOWN" to choose the desired configuration.
- press "ENTER" again to confirm your choice: the display will return with a fixed light and it will show the selected configuration.

#### **4) UHF cluster attenuation levelling**

The attenuation of each cluster can be levelled from 0 to -30 dB with 1 dB steps.

The cluster can also be switched off.

This function will be shown on the display by the visualisation of "L+ cluster number".

#### **Procedure**

From the cluster-groups' visualisation/configuration mode you can sequentially go to the visualisation of the clusters' levels + channels parameters.

To enter into the adjustment mode:

- press the "ENTER" key. The display will start blinking. This indicates the parameters' setting mode.
- press "UP" or "DOWN" to adjust the cluster's attenuation level.
- press "ENTER" again to confirm your choice.

To deactivate a cluster:

- press the "ENTER" key .The display will start blinking. This indicates the parameters' setting mode.
- press the "UP" and "DOWN" keys simultaneously.
- the display will show the word **o F**.
- press "ENTER" again to confirm your choice.

#### **5) Clusters' amplitude setting**

The bandwidth (from 1 to 7 channels) and the attenuation level (from 0 to -30 dB Typ) of the 10 clusters can be independently adjusted.

For the setting you need to select the desired cluster (F1...F0) and then adjust the attenuation level, if you require to use it, or

switch it off choosing **o F**.

Afterwards you can select the cluster's start and stop channels.

If you switch a cluster off, it is better to reset its channels to zero choosing **o F**.



## Procedure

- start from visualisation mode (display fixed switched on) of the first cluster's level settlement.
- press the "UP" key: the display will show the F1 cluster .
- The display will also indicate the F1 cluster's start channel by the lighting of the second LED.
- press "UP" again .
- the display will show the F1 cluster's stop channel followed by a dot **F I 27.**

## Note:

If the start channel is at the same value as the stop one ( single-channel setting) the display will indicate this mode viewing the word **o F** as cluster's stop channel **F I oF.**

To reset the cluster's start channel:

- select the desired cluster on the display.
- the lighting of the second LED confirms that you are at the cluster's start channel.
- press the "ENTER" key .The display will start blinking.
- press "UP" to increase the channel's number or "DOWN" to decrease it.
- press "ENTER" again to confirm your choice.

To reset the cluster's stop channel:

- press the "UP" key.
- the lighting of the fourth LED confirms that you are at the cluster's stop channel.
- press the "ENTER" key .The display will start blinking.
- press "UP" to increase the channel's number or "DOWN" to decrease it.
- press "ENTER" again to confirm your choice.

To deactivate the cluster's start or stop channel:

- press the "UP" and "DOWN" keys simultaneously.
- the display will show the word **o F.**

## Note:

Channel overlapping is possible and it is shown on the display by the rapid blinking of the overlapped clusters.

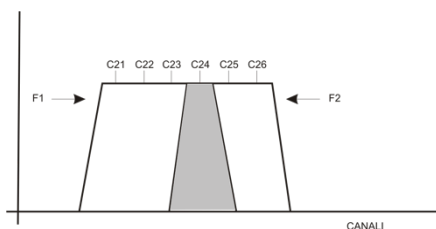

## Note:

The setting of the F1 cluster's start channel at the value 21 and of the stop channel at the value 24 while the F2 cluster has the start channel at the value 24 and the stop channel at the value 26 implicates an overlapping of the F1 cluster's stop channel with the F2 cluster's start channel.

## 5) Interstage attenuator regulation (UHF output level)

After the input levels' setting a further adjustment of the total output level of the UHF signals can be useful.

### Procedure

- press the "UP" or "DOWN" key to select **LU.00** on the display.
- press the "ENTER" key .The display will start blinking. This indicates the parameters' setting mode. - press "UP" or "DOWN" to adjust the UHF total attenuation level.
- press "ENTER" again to confirm your choice.

## 6) B I/FM and B III/DAB input level adjustment.

The B I/FM and B III inputs are provided with level attenuators from 0 to –25 dB with 1 dB step.

### Procedure

- press the "UP" or "DOWN" key to select **b1.00.** or **b3.00.** on the display.
- press the "ENTER" key. The display will start blinking. This indicates the parameters' setting mode.
- press "UP" or "DOWN" to adjust the band I and band III cluster attenuation level.
- press "ENTER" again to confirm your choice.

**NOTE: the attenuation settings will be cancelled without pressing the "ENTER" key for confirmation at the procedure's end.**

## 7) Clusters Self-Alignment Setting

SELF-ALIGNMENT can be used after programming all the UHF clusters. Running this function the programmable amplifier will automatically level all clusters to get an equalized and optimized output.

To set the SELF-ALIGNMENT select the **L. E. v. L.** menu and press the ENTER key, when the display start flashing press again the key ENTER and the display show the word **A D J** followed by a moving cursor. Wait till the procedure is finished.

The SELF-ALIGNMENT algorithm provides an UHF output level standard of 100 dB $\mu$ V.

With input UHF signals  $\geq 70$  dB $\mu$ V the inter-stage attenuator will be set at – 10dB level. This allows an output level range that can be set from 95 dB $\mu$ V to 110 dB $\mu$ V.

With input UHF signals  $\geq 60$  dB $\mu$ V and  $\leq 70$  dB $\mu$ V the inter-stage attenuator will be set at 0 dB.

This allow an output level range that can be set from 80 dB $\mu$ V to 100 dB $\mu$ V.

With input UHF signals that are too low, to guaranty a good Signal/Noise ratio the display alert will show the cluster number followed by the symbol **Lo** . Press the key ENTER to continue.

With input UHF signals too high the display alert will show the cluster number followed by the symbol **Hi**. Press the key ENTER to continue.

## Safety Code

To enable or change the safety three digit PIN code go to the **P.000** menu, press the key ENTER to activate the procedure (flashing display) press the keys UP or DOWN to set the first digit and confirm pressing ENTER. Follow the same procedure to set the other two digits.

The code **P.000** = PIN code disabled (default setting).

## 7) Remote power supply

Each “RF” input can supply 12 or 24 VDC power, 100mA. \*

\*amount of the total consumption of all the remote power supplied inputs.

### Procedure

- You can enter into the remote power supply setting menu only if the display is in “POWER ON” status.

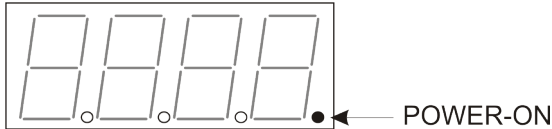

- if the amplifier is not yet in the “POWER ON” mode, then press the “UP” and “DOWN” keys simultaneously.
- keep pressing the “UP” key for 3 seconds.
- the display will indicate the remote power supply menu.

To set the remote power supplied voltage:

- press the “ENTER” key. The display will start blinking. This indicates the parameters’ setting mode.
- press “UP” or “DOWN” to select 12 or 24 Volt voltage.
- press “ENTER” again to confirm your choice.

To switch on the remote power supply or to check its presence at the UHF and VHF inputs of the amplifier:

- press “UP” or “DOWN”.
- the “UHF1”, “UHF2”, “bI”, “bIII ” inputs will be sequentially viewed on the display.
- for each input: “oF” means that input doesn’t provide remote power supply.
- for each input: “on” mean that input provides remote power supply.

To change the mode:

- press “ENTER”.
- press “UP” or “DOWN” to select “on” or “oF” .
- press “ENTER” again to confirm your choice.

To leave the remote power supply setting menu:

- press the “UP” and “DOWN” keys simultaneously.
- the display will return to “POWER ON” status.

If a short circuit or an overload occurs to one input or more, the first LED on the display will start blinking.

**In case of short circuit: switch the amplifier off by disconnecting the mains cable. Remove the problem’s origin, then switch the amplifier on.**

## 8) Amplifier’s initial setting restoration

The amplifier can be reset at any time, this restores the initial factory setting. This will remove all of the individual settings that have been previously entered. The amplifier will need to be reprogrammed at this stage.

## **Procedure**

- disconnect the mains cable of the power supplier unit from the 220V electric system.
- keep pressing the “ENTER” key .
- in the meantime reconnect the 220V mains cable.
- wait till the display indicates 4 hyphens (it means that the reset was successful) .
- then release the “ENTER” key.
- the display will return to “POWER ON” status.
- now the amplifier is programmable again.